

ifm electronic



Operating instructions  
Flow monitor

**efector300<sup>®</sup>**

**SI0557**

**UK**

706224 / 00 08 / 2012

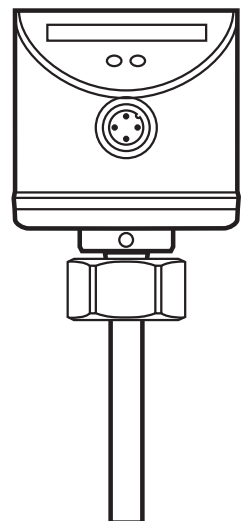

# Contents

1 Preliminary note.....	3
2 Safety instructions .....	3
3 Functions and features .....	4
3.1 Application area .....	4
3.2 Operating principle flow monitoring .....	4
4 Installation.....	5
4.1 Installation location .....	5
4.2 Interference in the pipe system .....	6
4.3 Installation procedure .....	6
5 Electrical connection.....	7
6 Operating and display elements .....	7
7 Set-up and settings for water.....	8
7.1 High flow adjustment (optional) .....	8
7.2 Setting switch point SP1 .....	9
7.3 Setting switch point SP2.....	9
8 Additional settings (optional).....	9
8.1 Low flow adjustment .....	9
8.2 Configuration of the switching outputs.....	10
8.3 Restore the factory setting (reset) .....	10
8.4 Lock / unlock the unit.....	10
9 Error during adjustment .....	11
10 Operation.....	11
11 Maintenance .....	12
12 Scale drawing and technical data .....	12

# 1 Preliminary note

- ▶ Instruction
- > Reaction, result
- Cross-reference



Important note

Non-compliance can result in malfunction or interference.



Information

Supplementary note.



LED lights green



LED lights orange



LED lights red



LED flashes

UK

## 2 Safety instructions

- Please read the product description prior to set-up of the unit. Ensure that the product is suitable for your application without any restrictions.
- The unit conforms to the relevant regulations and EC directives.
- Improper or non-intended use may lead to malfunctions of the unit or to unwanted effects in your application.
- That is why installation, electrical connection, set-up, operation and maintenance of the unit must only be carried out by qualified personnel authorised by the machine operator.









# 3 Functions and features

## 3.1 Application area

The unit monitors the flow in liquid and gaseous media.

## 3.2 Operating principle flow monitoring

- The unit detects the flow speed to the calorimetric measuring principle and switches the outputs S1 and S2.
- Factory setting 1 x normally closed (S1); 1 x normally open (S2):

Flow	Output S1 (normally closed)	Output S2 (normally open)
< SP1	closed 	open 
≥ SP1	open 	open 
< SP2	open 	open 
≥ SP2	open 	closed 

- ▶ Reversion of the output function normally closed / normally open → 8.2.
- If the flow speed increases, the switching status changes when the switch point is reached.
- If the flow speed falls again, the switching status changes when the value "SP minus hysteresis" is reached.  
The hysteresis changes with the flow speed and it is essentially influenced by the set monitoring range.  
It is 2...5 cm/s for the setting 5...100 cm/s (= in water), it increases with higher flow speeds.
- The typical response time of the unit is 1...10 s. It can be influenced by the setting of the switch point:
  - Low switch point = quick reaction with rising flow.
  - High switch point = quick reaction with falling flow.

## 4 Installation

Using process adapters the unit can be adapted to different process connections.

- The adapters have to be ordered separately as accessories.

A correct fit and function of the unit and ingress resistance of the connection are only ensured using ifm adapters.

- For small flow rates ifm adapter blocks are available.

### 4.1 Installation location

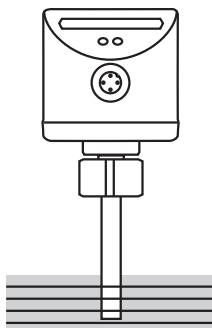
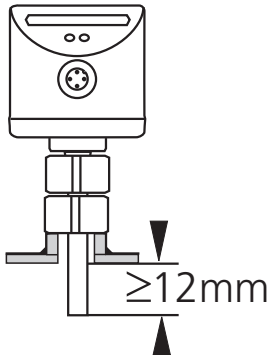
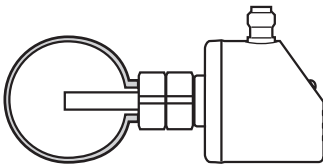
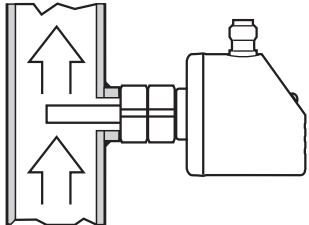
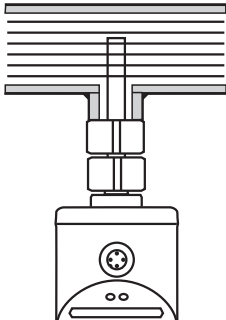
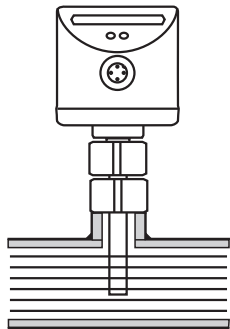
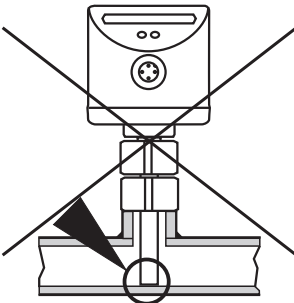
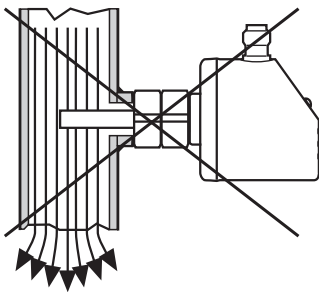
<p><b>In general</b></p> <ul style="list-style-type: none"> <li>• The sensor tip is to be completely surrounded by the medium.</li> <li>• Insertion depth of the sensor: minimum 12 mm.</li> </ul>		
<p><b>Recommended</b></p> <ul style="list-style-type: none"> <li>• For horizontal pipes: mounting from the side.</li> <li>• For vertical pipes: mounting in the rising pipe.</li> </ul>		
<p><b>Conditionally possible</b></p> <ul style="list-style-type: none"> <li>• Horizontal pipe / mounting from the bottom: if the pipe is free from build-up.</li> <li>• Horizontal pipe / mounting from the top: if the pipe is completely filled with medium.</li> </ul>		
<p><b>To be avoided</b></p> <ul style="list-style-type: none"> <li>• The sensor tip must not be in contact with the pipe wall.</li> <li>• Do not mount in downpipes that are open at the bottom!</li> </ul>		

## 4.2 Interference in the pipe system

Components integrated in the pipes, bends, valves, reductions, etc. lead to turbulence of the medium. This affects the function of the unit.

Recommendation: adhere to the distances between sensor and sources of interference:

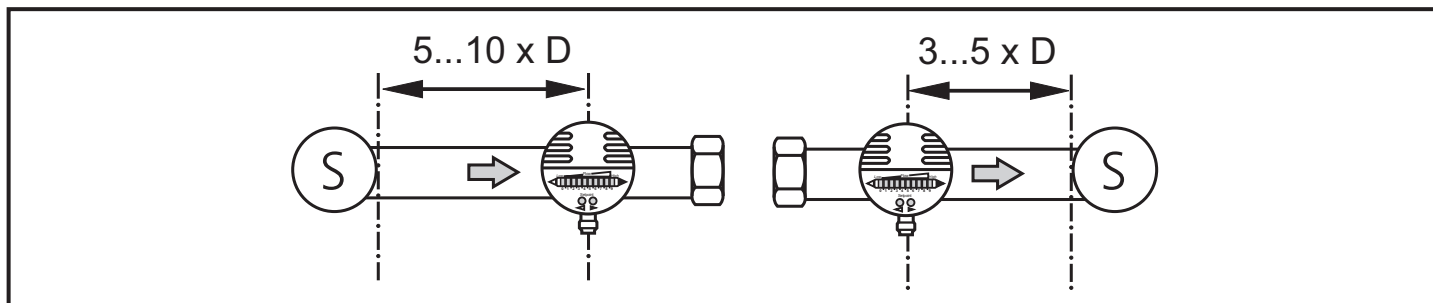

$D$  = pipe diameter;  $S$  = sources of interference

## 4.3 Installation procedure



- ▶ Ensure that the system is free of pressure during installation.
- ▶ Ensure that no media can leak at the mounting location during installation.

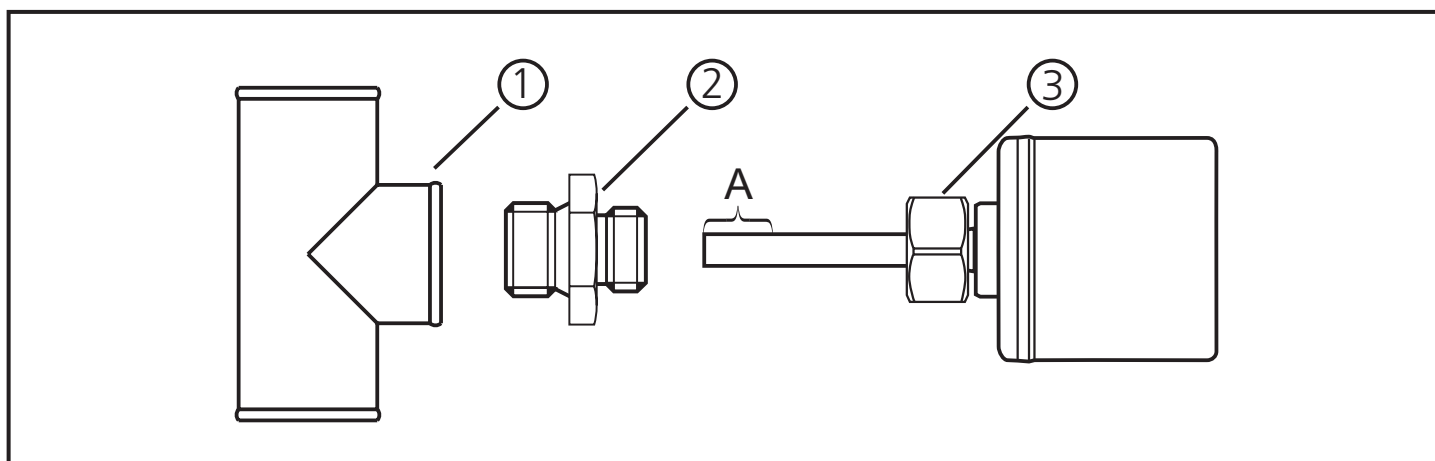

- ▶ Grease the threads of the process connection (1), adapter (2) and nut (3). Attention: The sensor tip (A) must not be in contact with grease.
- ▶ Screw the suitable adapter into the process connection.
- ▶ Place the flow monitor onto the adapter and tighten the nut. Tightening torque 250 Nm. Ensure that the unit is correctly oriented.

## 5 Electrical connection



The unit must be connected by a qualified electrician.

The national and international regulations for the installation of electrical equipment must be adhered to.

Voltage supply to EN 50178, SELV, PELV.

- ▶ Disconnect power.
- ▶ Connect the unit as follows:

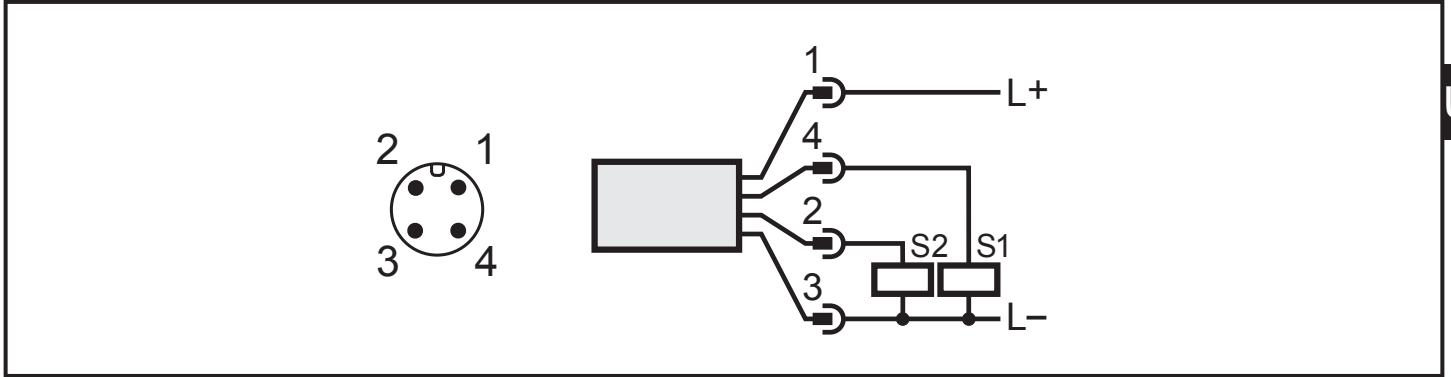

UK

## 6 Operating and display elements

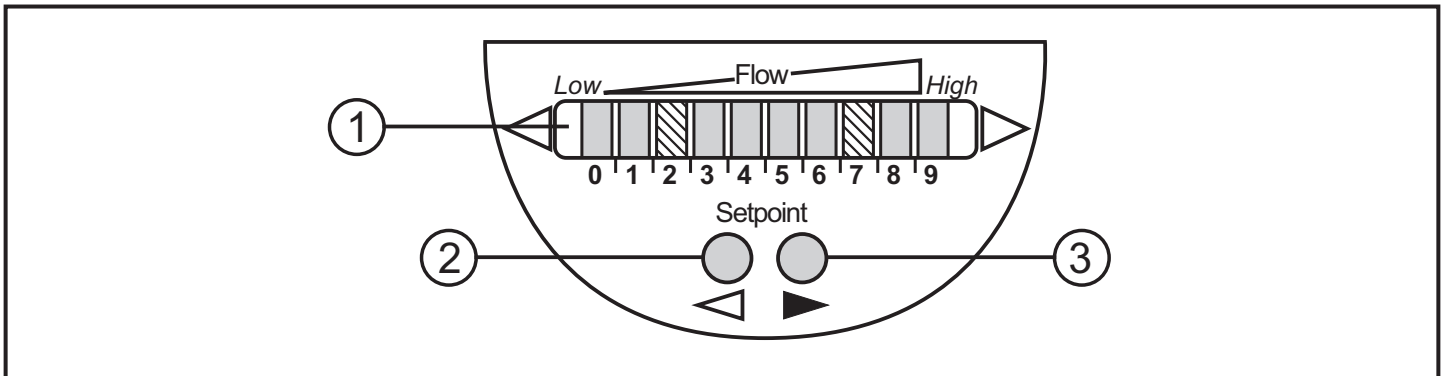

### 1: Operation indication

- The green LEDs indicate the current flow (LEDs 0 to 9 represent the range between flow standstill and maximum flow).
- 2 LEDs indicate the position of the switch points (orange = output closed, red = output open).

### 2, 3: Setting buttons for adjustment and configuration

# 7 Set-up and settings for water

(For media other than water → 8.1 Low flow adjustment).

- ▶ Switch on the supply voltage.
- > All LEDs light and go out again step by step. During this time, the outputs S1 and S2 are open (factory setting, in case of reprogramming both outputs are closed). The unit is in the operating mode.
- ▶ Let the normal flow circulate in the installation.
- ▶ Check the display and determine further actions.

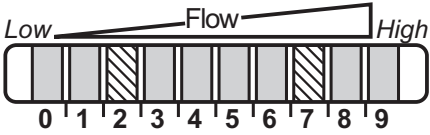
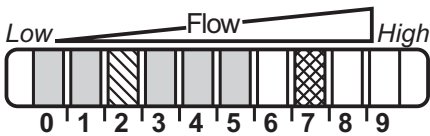
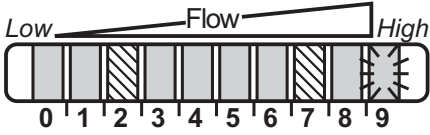
1		<p>The factory set operating range is suited for the application.</p> <ul style="list-style-type: none"> <li>▶ Adapt the switch points to the application if required (→ 7.2; → 7.3).</li> </ul>
2		<p>Your normal flow is below the representation range of the display.</p> <ul style="list-style-type: none"> <li>▶ Carry out high flow adjustment (→ 7.1).</li> <li>▶ Adapt the switch points to the application (→ 7.2; → 7.3).</li> </ul>
3		<p>Your normal flow exceeds the representation range of the display (LED 9 flashes).</p> <ul style="list-style-type: none"> <li>▶ Carry out high flow adjustment (→ 7.1).</li> <li>▶ Adapt the switch points to the application (→ 7.2; → 7.3).</li> </ul>

You can restore the factory setting any time (→ 8.3).

## 7.1 High flow adjustment (optional)

The unit determines the existing flow as normal flow and adapts the display representation (all LEDs except the switch point LED light green).



- ▶ Let the normal flow circulate in the installation.
- ▶ Press ► and keep it pressed.
- > LED 9 lights, after approx. 5 s it flashes.
- ▶ Release the button.

The unit is now adapted to your flow conditions. It returns to the operating mode, the display should now show example 1.

Note: The adjustment influences the switch points: they are proportionally increased.





## 7.2 Setting switch point SP1

- ▶ Press the button  briefly.
- > LED for SP1 flashes red, LED for SP2 lights red.
- ▶ Press  or  as often as required. Each press of the pushbutton shifts the LED by one position in the indicated direction.

Note: If no pushbutton is pressed for 2 s, the unit returns to the operating mode with the newly set value.

## 7.3 Setting switch point SP2

- ▶ Press the button  briefly.
- > LED for SP2 flashes red, LED for SP1 lights red.
- ▶ Press  or  as often as required. Each press of the pushbutton shifts the LED by one position in the indicated direction.

Note: If no pushbutton is pressed for 2 s, the unit returns to the operating mode with the newly set value.

# 8 Additional settings (optional)

## 8.1 Low flow adjustment

If the unit is used in media other than water, you should additionally adapt the unit to the minimum flow.

Attention: The following adjustment must only be carried out after the high flow adjustment.

- ▶ Let the minimum flow circulate in the installation or ensure flow standstill.
- ▶ Press  and keep it pressed.
- > LED 0 lights, after approx. 5 s it flashes.
- ▶ Release the button. The unit adopts the new value and returns to the operating mode.

## 8.2 Configuration of the switching outputs

Factory setting 1 x normally closed (S1); 1 x normally open (S2).

Reversion of the programming:

- ▶ Press the pushbutton  for at least 15 s.
- > LED 0 lights, after approx. 5 s it flashes.
- > After 10 s the current setting is displayed: LEDs 5...9 light orange.
- > After approx. 15 s LEDs 0...4 flash orange.
- ▶ Release the button.
- > The outputs are set to 1 x normally open (S1); 1 x normally closed (S2).

For a new changeover: repeat the operation.

## 8.3 Restore the factory setting (reset)

- ▶ Press  for at least 15 s.
- > LED 9 lights, after approx. 5 s it flashes.
- > After approx. 15 s LEDs 0...9 flash orange.
- ▶ Release the button. All settings are reset to the factory setting.

## 8.4 Lock / unlock the unit

The unit can be locked electronically to prevent unintentional settings.

- ▶ Press both setting buttons simultaneously for 10 s in the operating mode.
- > The indication goes out, the unit locks or unlocks.

On delivery: unlocked.

## 9 Error during adjustment

If no adjustment is possible, all LEDs flash red. The unit then returns to the operating mode with unchanged values.

### Possible cause / aid:



Error during installation.	► Read chapter 3 Installation. Check whether all requirements have been met.
The difference between maximum flow and minimum flow is too small.	► Increase the flow difference and carry out the adjustment again.
The sequence high flow / low flow adjustment was not adhered to.	► Carry out the two adjustment operations again in the right sequence.

UK

## 10 Operation

After every power on all LEDs light and go out again step by step. During this time, the outputs S1 and S2 are open (factory setting, in case of reprogramming both outputs are closed). The unit is then ready for operation.

In case of power failure or interruption all settings remain.

Operating indicators	
 <p>0 1 2 3 4 5 6 7 8 9</p>	<p>Green LED bar: current flow within the display range.</p> <p>Display of the switch points (SP1 / SP2):</p> <ul style="list-style-type: none"> <li>- LED orange: output closed.</li> <li>- LED red: output open.</li> </ul>
 <p>0 1 2 3 4 5 6 7 8 9</p>	<p>LED 9 flashes: current flow above the representation range.</p>
 <p>0 1 2 3 4 5 6 7 8 9</p>	<p>LED 0 flashes: current flow far below the display range.</p>

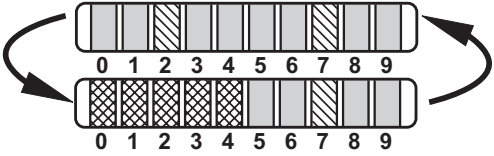
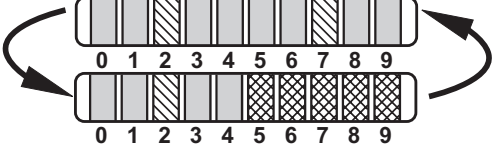
Fault indication	
	<p>Short circuit on output S1: The operating indicator and 5 red LEDs on the left light alternately. If the short circuit has been rectified, the unit immediately passes into the normal operating state. The current operating state is displayed.</p>
	<p>Short circuit on output S2: The operating indicator and 5 red LEDs on the right light alternately. If the short circuit has been rectified, the unit immediately passes into the normal operating state. The current operating state is displayed.</p>
<p>Display OFF (no LED lights):</p>	<p>Operating voltage too low (&lt; 19 V) or failed. ▶ Ensure a correct voltage supply.</p>
	<p>Internal sensor error &gt; All outputs are switched off, irrespective of their setting normally closed / normally open.</p>

## 11 Maintenance

Recommended maintenance:

- ▶ Check the sensor tip for build-up from time to time.
- ▶ Clean it using a soft cloth. Stubborn build-up (e.g. lime) can be removed using a common vinegar cleaning agent.

## 12 Scale drawing and technical data

→ [www.ifm.com](http://www.ifm.com)

More information at [www.ifm.com](http://www.ifm.com)





